

**Operating
and service
information**

DN510

Advanced Dual Gate



**Audio engineering
like no other
in the world**

CONTENTS

INTRODUCTION	4
INSTRUMENT FAMILIARISATION	5
USING THE DN510 ADVANCED DUAL GATE	9
CORRECTIVE APPLICATIONS	9
CREATIVE APPLICATIONS	15
AUDIO AND MIDI CONNECTIONS	20
SPECIFICATIONS	22
CIRCUIT DESCRIPTION	24
SCHEMATIC DIAGRAMS	
MIDI SETTING CHART	33
WARRANTY	37
SERVICE REQUEST FORM	38
WORLDWIDE DISTRIBUTION	40
PRODUCT REGISTRATION AND INFORMATION REQUEST CARDS	

Sound System Design and Engineering Seminars

Klark Teknik regularly organises technical seminars at locations throughout the world. If you would like to attend any of these seminars, please tick the box on the enclosed product registration card, or write to Klark Teknik, England, to the International Marketing Services Department. We will inform you of forthcoming events.

If you cannot attend any of the seminars, you can as a user obtain the complete seminar material for a nominal charge.

Klark Teknik designs and manufactures a variety of products for the professional audio industry. If you would like us to send information on these products, simply tick the appropriate box on the information request reply card.

Thank You for using this Klark Teknik Product

To obtain maximum performance from this precision electronic product, please study these instructions carefully. Installing and operating the Advanced Dual Gate is not complicated, but the flexibility provided by its operating features merits familiarisation with its controls and connections. This unit has been prepared to comply with the power supply requirements that exist in your location.

Precautions

Do not install this unit in a location subject to excessive heat, dust, or mechanical vibrations.

Before connecting this unit to the mains power supply, check that the operating voltage is correct for your local supply.

It is important that you observe the following instructions if a different voltage setting is required:

Voltage Selection and Power Connection

Connection is by means of an IEC standard power socket. The rear panel voltage label indicates the voltage required for the satisfactory operation of the unit.

Before connecting this unit to the mains supply, ensure that the fuse is of the correct type and rating, as indicated on the rear panel adjacent to the fuse holder.

To change the mains voltage selector, move the switch over to the appropriate position. Replace the voltage label with a new one showing the new voltage setting. Set the correct voltage **before** connection to the mains supply.

Safety Warning

This unit is fitted with a 3-pin power socket. For safety reasons, the earth lead should not be disconnected.

To prevent shock or fire hazard, do not expose the unit to rain or moisture.

To avoid electric shock, do not remove covers. Refer servicing to qualified personnel only.

After you have unpacked the unit

Save all the packing materials. They will prove valuable should it become necessary to transport or ship this unit.

Please inspect the unit carefully for any signs of damage incurred during transportation. It has undergone stringent quality control inspection and tests prior to packing, and left the factory in perfect operating and mechanical condition.

If, however, the unit shows any sign of damage, notify the transportation company without delay. Only you, the consignee, may institute a claim against the carrier for damage during transportation.

If necessary, contact your supplier. Or, as a last resort, your Klark Teknik importing agent*, who will fully co-operate under such circumstances.

* See enclosed world-wide importing agents list.

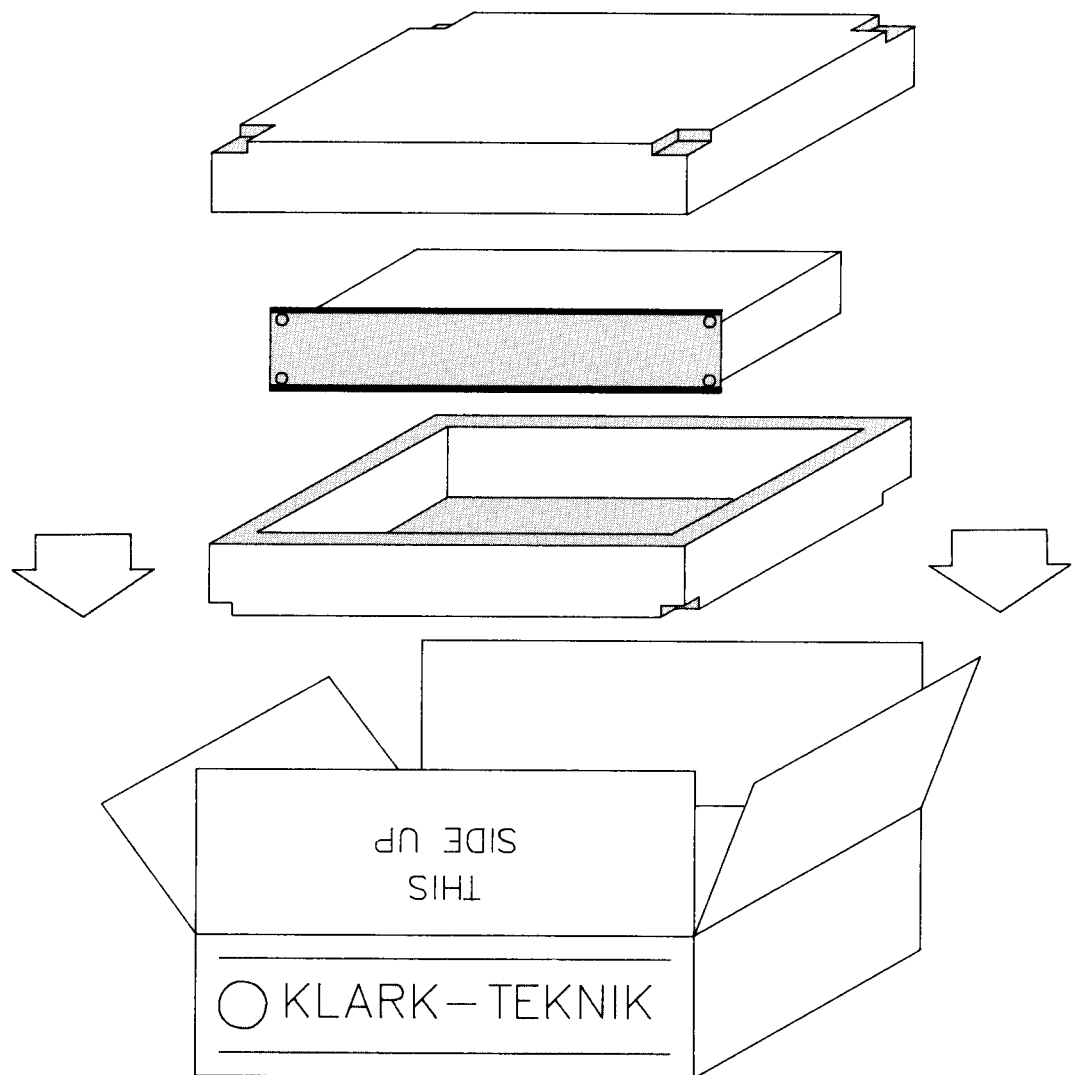

Introduction

Noise gating is a powerful technique for improving the clarity of a mix, whether in PA work or in the studio. It also has the creative potential to alter the dynamics and the character of musical sounds.

The Klark Teknik DN510 Advanced Dual Gate has been designed to enable the studio or PA engineer greatly to improve the quality of sound achievable by gating out unwanted background clutter or tape hiss. It also provides facilities over and above those found on conventional noise gates and vastly increases the creative potential of the technique.

The DN510's features include the output of MIDI data, so that the precise audio sensing functions of the unit may be used to trigger a drum machine or sampler to replace a less-than-perfect drum track with high quality samples while retaining the original dynamics. The MIDI outputs of several DN510 units may be cascaded using the MIDI MERGE feature. DC trigger inputs and outputs are provided for control of non-MIDI equipment, and for remote keying of the DN510.

Advanced features include Trigger Mask, Envelope Delay and a Fixed Envelope setting:

The Mask function completely eliminates the gate 'jitter' that would otherwise require the careful adjustment of Hold and Release time to remove. It can also be used creatively to remove offbeats, drum fills or echo. In conjunction with MIDI, Mask can allow rhythmic effects to be generated.

The Delay function introduces an initial delay before the gate opens and can produce 'slap-back' effects, control percussion reverb and enable time shifting between audio trigger and MIDI output.

The Fixed Envelope function allows precise dynamic modification of natural or sampled sounds, and enables MIDI note lengths to be defined.

High and low frequency filters are provided for frequency conscious gating or for the tailoring of programme bandwidth. A Duck function is available for externally keyed programme level changes.

The DN510 Advanced Dual Gate is built to Klark Teknik's high standards of design and construction. The facilities it offers break new ground in audio and MIDI control.

Instrument familiarisation

Front panel controls

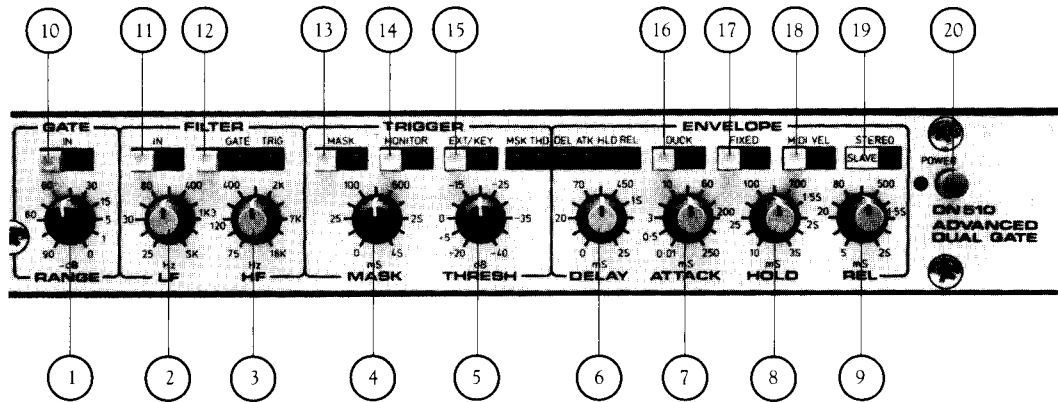

The DN510 Advanced Dual Gate consists of two identical channels.

Rotary Controls

Gate

1. **RANGE** sets the degree of attenuation provided when the gate is closed, variable from 0dB to 90dB.

Filter

2. **LF** applies low frequency filtering to the side chain of the gate from 25Hz to 5kHz, with a roll-off rate of 12dB per octave.
3. **HF** applies high frequency filtering to the side chain of the gate, from 18kHz down to 75Hz, with a roll-off rate of 12dB per octave.
The filters can alternatively be applied to the programme itself, rather than to the side chain.

Trigger

4. **MASK** sets the length of time during which the gate, once triggered, will not retrigger. Variable from 0 seconds to 4 seconds. An LED indicates when Trigger Mask is operative.
5. **THRESH** (Threshold) determines the level at which the gate will open, variable from -40dBu to +20dBu. An LED indicates when the threshold level has been exceeded and the gate is open.

Envelope

6. **DELAY** sets the time taken for the envelope to start its Attack phase after the gate is triggered. An LED indicates the duration of the Delay phase. Delay is variable between 0 and 2 seconds.

7. **ATTACK** sets the time taken for the gate to open fully once it is triggered, variable from 10 microseconds to 250 milliseconds. An LED indicates the Attack phase of the envelope and increases in brightness as the gate opens.
8. **HOLD** sets the amount of time that the gate will remain open when the signal has fallen below the threshold level. An LED indicates the Hold phase of the envelope. Hold is variable from 10mS to 3S.
9. **REL** (Release) is adjustable from 5 milliseconds to 2 seconds. An LED indicates the Release phase of the envelope and decreases in brightness as the gate closes.

Switched controls

Gate

10. **IN** switches the gate in or out of circuit.

Filter

11. **IN** switches the LF and HF filters in or out of circuit.
12. **GATE/TRIG** switches the filters into either the main signal path for filtering the programme material, or into the side chain for frequency-conscious gating.

Trigger

13. **MASK** activates the Trigger Mask function.
14. **MONITOR** switches the trigger signal to the audio output of the gate, allowing the engineer to assess the effects of the LF and HF filters.
15. **EXT/KEY** allows triggering of the gate by a signal applied to the EXT/KEY socket on the rear panel.

Envelope

16. **DUCK** reverses the normal operation of the gate so that signals below the threshold pass through while signals above the threshold are attenuated.
17. **FIXED** forces the envelope, once triggered, to follow the timed sequence as set on the controls. If Fixed is not selected, the Hold phase will commence when the signal level passes below the threshold.
18. **MIDI VEL**, when selected, allows the level of incoming audio to control the MIDI Velocity values output by the DN510 and thus control the level of a drum machine or sampler.
19. **STEREO** links the two channels of the DN510 together, so that they are both operated from the controls of the left hand channel. The Trigger and Envelope controls of the right hand channel remain active for MIDI operation.
20. **POWER** switches mains power on or off.

Rear Panel Functions

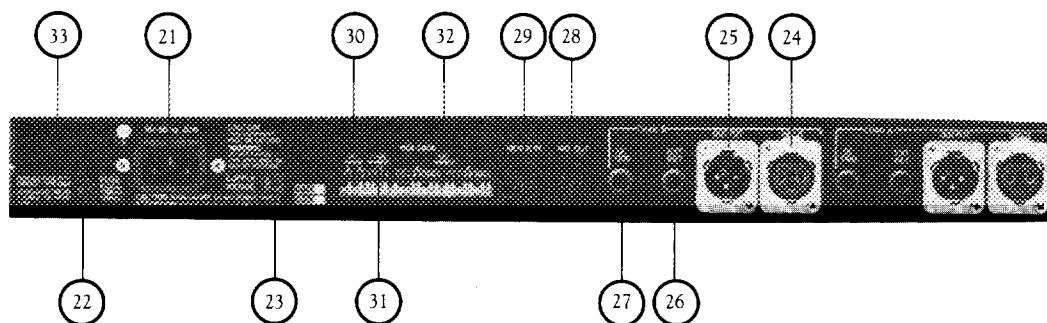

21. **Mains** is supplied via an IEC standard 3-pin connector. A compatible power cord is supplied with the unit.
22. The **mains fuse** is located next to the mains inlet connector. Always replace with the correct type and rating as indicated on the unit.
23. **Voltage selector switch.** This unit is switchable between two nominal supply voltages, 110V and 220V, via a slide switch. The switch **MUST** be set before the supply is connected. Any attempt to run the unit from a 220V supply with the switch set to 110V is liable to result in severe damage to the unit.
24. **Signal Input** is made via a female XLR type connector. For wiring details see page 20 of this manual.
25. **Signal Output** is available on a male XLR type connector. For wiring details see page 20 of this manual.
26. **External Key Input** is made via a 1/4 inch type A stereo jack connector.
27. **DC Trigger** input allows keying of the gate by a +5 volt pulse. Input and Output are on the ring and tip of a 1/4 inch type A stereo jack connector.
28. **MIDI OUT** sends MIDI Note On and Note off messages (including MIDI Channel Number and Velocity) corresponding to the opening and closing of the gates.
29. **MERGE IN** allows the MIDI OUTs of several DN510 units to be cascaded.

MIDI Data Switches (for setting details see page 33):

30. **Velocity Range** sets the range of audio levels for which MIDI Velocity values 0 to 127 will be transmitted.
31. **Channel Number** sets the MIDI Channel Number (1 to 16) for each channel of the DN510.
32. **Key Number** sets the MIDI Key Number on which each channel of the gate will transmit MIDI Note On and Note Off.
33. **Always quote the Serial Number** in any correspondence concerning the unit.

Using the DN510 Advanced Dual Gate

The DN510 has two contrasting spheres of use: For corrective purposes, where any noise component present in a signal can be made substantially less of a problem, and for creative applications where the dynamics of a signal are artistically restructured.

CORRECTIVE APPLICATIONS

The human ear is connected to an extremely sophisticated organ for processing incoming audio information – the brain. Even in situations where there are many interacting sound sources we seem to be able to ‘tune in’ on the sounds we want to hear and reject others. This is sometimes known as the ‘cocktail party effect’ where it is possible to pick out one person’s voice – even at a distance – from many conflicting conversations.

The microphone is less selective in its pick up, being sensitive to ALL sounds within its range and coverage angle. For example, a microphone set to pick up the snare drum of a drum kit will pick up every other drum and cymbal to some extent, and probably the bass guitarist as well. When several microphones are positioned on the kit, each one giving a good sound on its own particular drum, they will all pick up unwanted instruments as well, making the sound less clear.

One solution to this problem is to use a noise gate on each microphone. The gate will reduce the output from the microphone to almost zero when the drum is silent, yet will open practically instantaneously when the drum is played. As the sound from the drum decays, the gate will close again and reject noise from the rest of the kit.

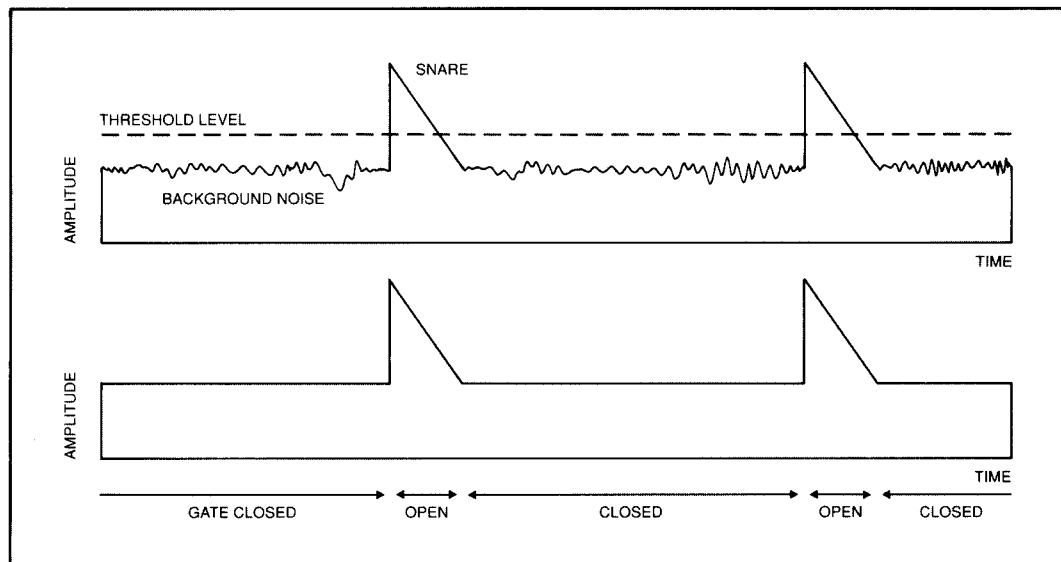

Diagram 1

The threshold level represents the sound level at which the gate will open. Any sound exceeding the threshold triggers the gate. Sounds at lower levels leave the gate closed and the microphone will be almost completely silent.

Interface with the console

The Klark Teknik DN510 Advanced Dual Gate is optimised for use at line level, therefore to gate a microphone, the input to the DN510 has to be taken from the console – preferably from the pre-EQ channel insert point send. The output from the DN510 comes back to the channel insert return. By connecting the DN510 at this position in the signal chain, its operation is unaffected by the use of any of the console controls, except Input Gain.

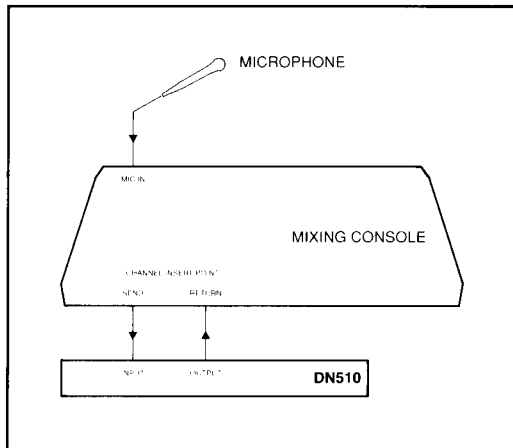

Diagram 2

The DN510 may, if desired, be connected via an auxiliary send and return, but if the aux send on your console is post-EQ, then operation of the EQ will alter the overall signal level and the threshold level of the DN510 will probably need adjustment.

Setting the Controls

The DN510 is a full-function high-performance dual noise gate, yet its design makes operation simple. Most important are the Threshold, Attack, Hold and Release controls.

THRESH (Threshold) sets the level at which the gate will open. Turning the control clockwise lowers the threshold level and allows quieter signals through. To set the threshold level, it is best to start off with the control fully clockwise. Then turn it anticlockwise, cutting out more and more noise, until the gate just starts to affect the signal you want to hear. Backing off around 5dB from this point will give a good threshold level for reliable triggering.

ATTACK sets the time it takes for the gate to open – for the VCA to go from almost infinite attenuation to zero attenuation. For sounds with a fast attack, such as drums and percussion, the attack time should be short – around 0.5 milliseconds. For sounds with a softer attack such as vocals, a longer attack time should be chosen. The optimum attack time for corrective applications is when the attack of the gate matches that of the signal so the maximum amount of noise is removed with the least detriment to the signal itself.

HOLD sets the amount of time the gate will remain fully open once the signal has passed below the threshold level. Hold is used when it is desirable to preserve the natural decay of a signal. When **FIXED** is active, the Hold phase of the envelope starts as soon as the Attack phase is over, without waiting for the signal to drop below the threshold level.

RELEASE sets the time it takes for the gate to close. The release time should be set to correspond with the decay of the signal. For instance, the sound from a drum decays very quickly, a sustained note on a piano takes much longer. The optimum release time is when the gate closes fast enough to prevent any noise from getting through, yet smoothly enough not to cut off the sound of the instrument prematurely.

Other important controls are Delay, Range and Mask.

DELAY sets the time which elapses before the envelope starts its Attack phase once the gate is triggered. It is used mainly in creative, rather than corrective, applications.

RANGE sets the degree of attenuation provided by the gate when it is closed. Usually, the Range will be set to its maximum value of 90dB. Occasionally, when a softer gating effect is required, Range will be set to a lower value.

MASK, or Trigger Mask to give it its full title, is used to prevent the gate retriggering too quickly. It sometimes happens during the decay of a signal that the gate will be 'fooled' into thinking that a new signal attack has started. Setting the Mask time appropriately prevents this. Mask is only active when the **MASK** button is depressed.

Between the Trigger and Envelope sections of each channel is an array of LED's which provides information on what is happening to the signal at any instant:

MSK indicates when Trigger Mask is active.

THD indicates that the signal is above the threshold level.

DEL indicates that the Delay phase of the envelope is active.

ATK fades up in brightness during the Attack phase of the envelope.

HLD indicates the Hold phase of the envelope.

REL decreases in brightness to indicate the Release phase of the envelope.

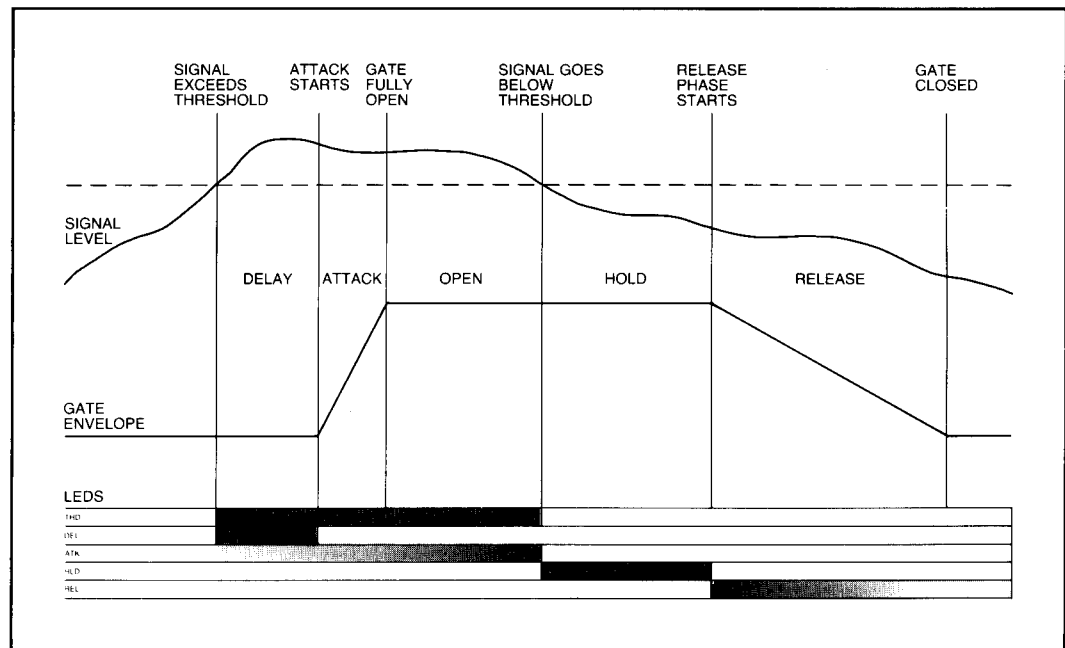

Diagram 3

Filter

It is most important for a noise gate to trigger reliably every time the instrument plays or vocalist sings, yet it should not be triggered by the occasional loud sound coming from some other instrument. In a drum kit, for instance, the snare drum and hihat cymbals are usually miked and gated separately, yet they may be so close that an almost equal level of signal from both instruments is being picked up by each microphone. This makes the threshold level very difficult to set correctly.

The solution to this problem is to tune the LF and HF filters of each gate to the principal band of frequencies produced by the respective instruments. The gate on the snare drum is tuned to a band of low frequencies, the gate on the hihat is tuned to the higher frequencies it produces:

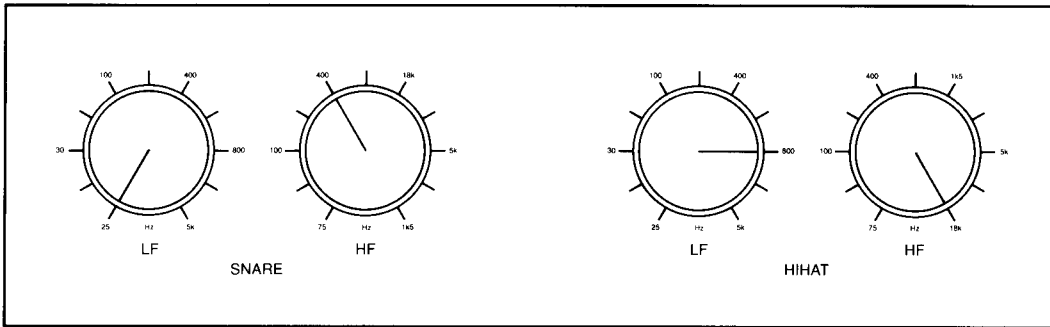

Diagram 4

For other instruments, and vocals, a mid-range band of frequencies may be selected:

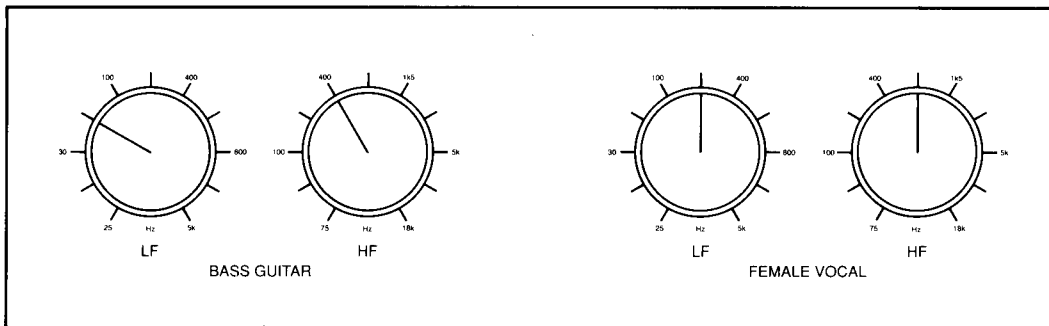

Diagram 5

It is possible to position the filters either in the side chain of the gate, for use as above, or in the main signal path acting as extra equalisation which, in itself, may reduce the noise content of a signal.

External Key

For most applications, the DN510 is triggered by the level of the signal being gated. Sometimes it can be beneficial to use a different signal to trigger the gate. This is known as an External Key for which there is a separate input on the rear panel.

Particularly in the case of drums, a very reliable trigger can be obtained by taping a contact microphone to the shell of the drum and using the clean signal it produces to trigger the gate:

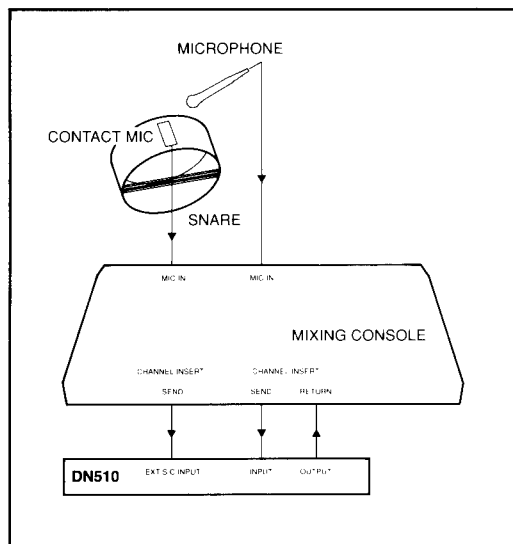

Diagram 6

Whether the key is derived internally from the main signal or from the External Key, the key signal can be heard by pressing the **MONITOR** button in the Trigger section of either channel.

Basic gating

Music PA

The more microphones there are in a PA system, the more background noise and stage clutter will be picked up and amplified – unless noise gating is used. The most significant improvement in clarity will be obtained by gating those microphones which are used **LEAST**, for example the mic used only occasionally by a backing vocalist.

Microphones used at a fairly high gain setting, for example on a string section, will pick up a lot of background noise. These should be gated too, to improve PA clarity.

As has already been mentioned, noise gates on the drum mics will also improve the sound of the kit.

Gating vocals

In a recording studio, vocals usually need to be gated – to remove studio ambience, headphone noise, breaths etc. This is best done after the vocal has been committed to tape, otherwise it may be possible to gate out accidentally something which should have been recorded.

If gating is carried out as the vocal is being recorded, it is important not to gate the signal before it is fed to the vocalist's headphones. Many vocalists find a gated headphone feed distracting, and it makes it more difficult to find the right note on which to come in.

Use with Compressors

One of the most important applications of a noise gate is the reduction of noise emphasised by the action of compressors. When any signal is compressed, the highest levels are reduced, but the lowest – noise – levels remain the same. This effectively decreases the signal to noise ratio.

By gating the signal before it enters the compressor, the noise can be eliminated before it has chance to be exaggerated by the compressor action:

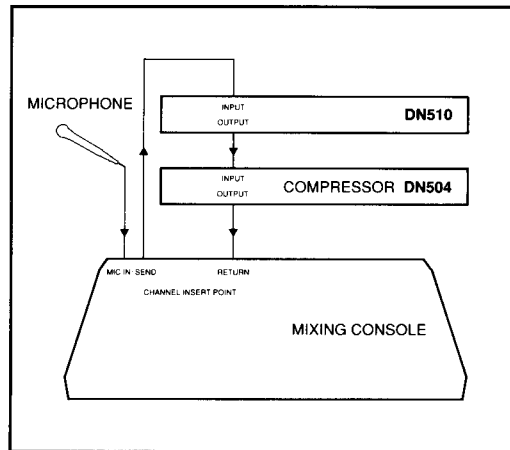

Diagram 7

Some engineers prefer to connect the gate after the compressor. This reduces any slight noise produced by the compressor itself, but since the dynamic range of the signal is less when it leaves the compressor, setting the correct threshold level may take a little longer. Alternatively, the uncompressed signal may be paralleled to the External Key input and used to trigger the gate.

Tape noise

During mixdown from multitrack tape, noise may become obvious. There are two ways in which this can be reduced using the DN510. The first is to gate the two noisiest tracks, probably those which are used at the highest levels, or have the most EQ applied.

Another way is to subgroup all the tracks, minus the reverb returns, and gate them. Without gating, noise becomes most obvious at the end of the music, as the reverb dies away. If the tracks are subgrouped and gated, then as soon as the instruments and vocals finish, the output from the multitrack tape will be muted, leaving the reverb to die away into a smooth silence:

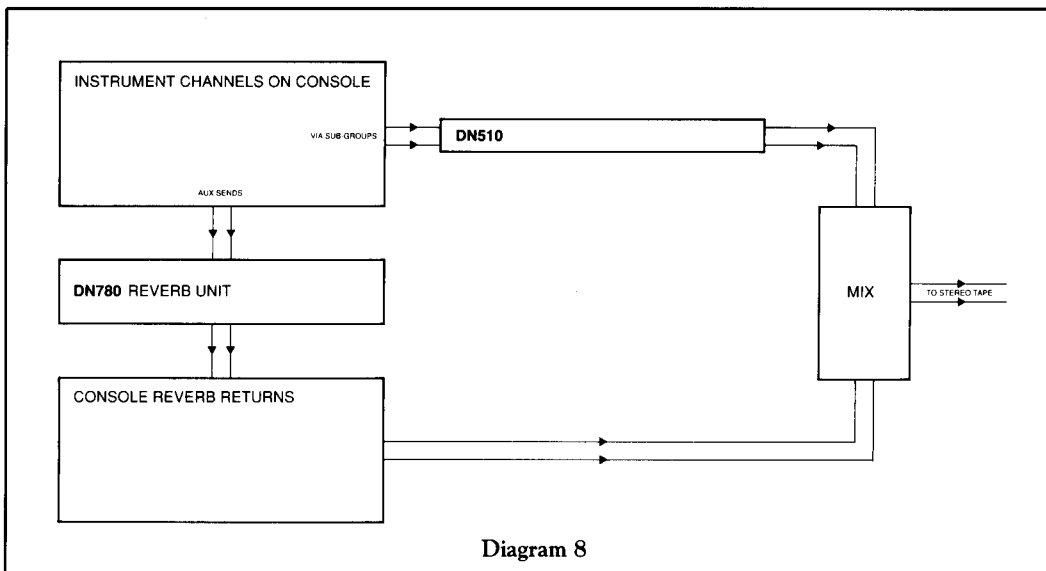

Diagram 8

CREATIVE APPLICATIONS

Gated Reverb

Gated reverb is a popular effect where a high level of reverb is used on a signal – often a snare drum – and a gate is used to chop off the tail of the reverb, giving a bright punchy sound.

This can be done without artificial reverberation by using two microphones. One mic is positioned close to the drum, another is set further away, to pick up the natural reverberation of the room. The outputs of the close mic and room mic are mixed to give a good sound, and the room mic passed through one channel of the DN510.

The External Key input is used, with the close mic giving a sharp attack pulse to trigger the gate. The Hold and Release times are set to give the best sounding decay on the reverb:

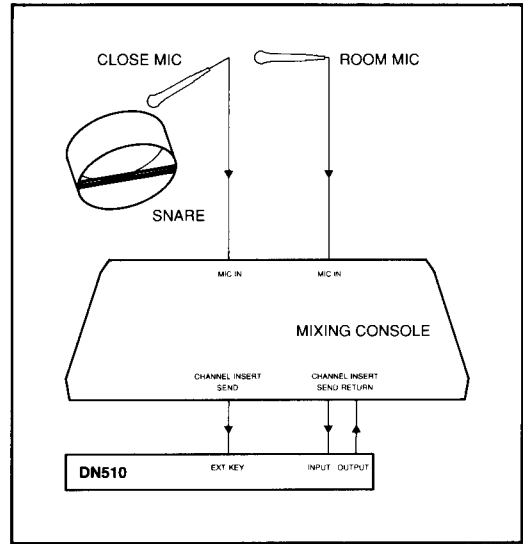

Diagram 9

Instrument Synchronisation

Sometimes it is necessary to synchronise the attack of two instruments. Often a bass guitar must be made to sync precisely to the regular beat of the bass drum. This can be done by passing the bass guitar through the gate, and using the bass drum as the External Key:

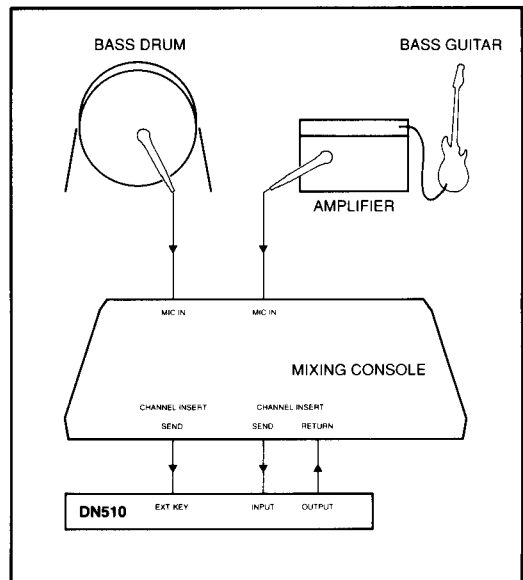

Diagram 10

Envelope shaping

A particularly important use of the DN510 is the shaping of drum envelopes. From an ordinary bass drum, snare or hihat beat – perhaps with a touch of compression and reverb added – an extraordinary range of different sounds can be obtained:

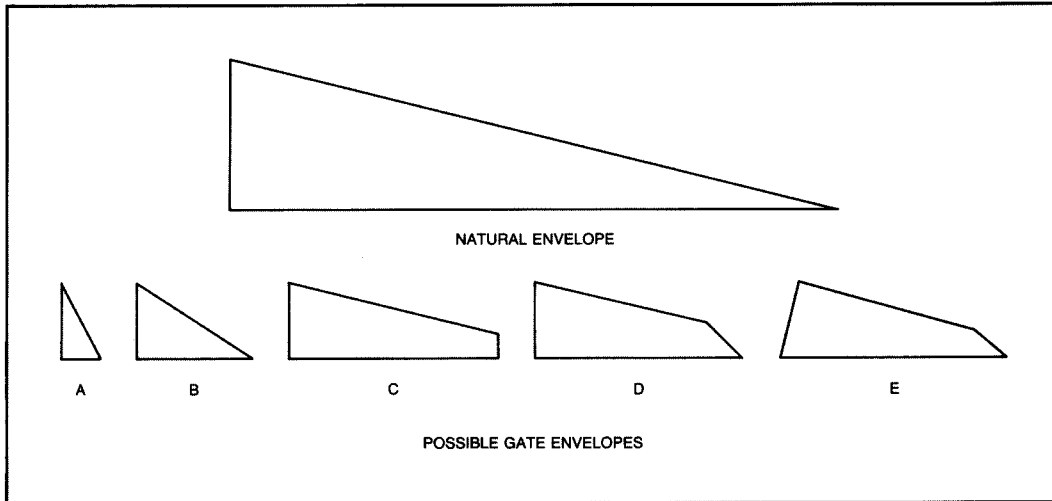

Diagram 11

A and B represent short, snappy drum sounds (minimum Attack and Hold times, short Release). C shows a longer sound with a very sharp decay (Hold is used to maintain the natural envelope. Release time is set to minimum). D has a slightly longer release, E softens the attack.

Another use of the envelope shaping capabilities of the DN510 is to produce a rhythmic pulse of 8th or 16th notes which goes all the way through a song – a common musical device. This could be a sequenced synthesiser, but a more interesting method is possible:

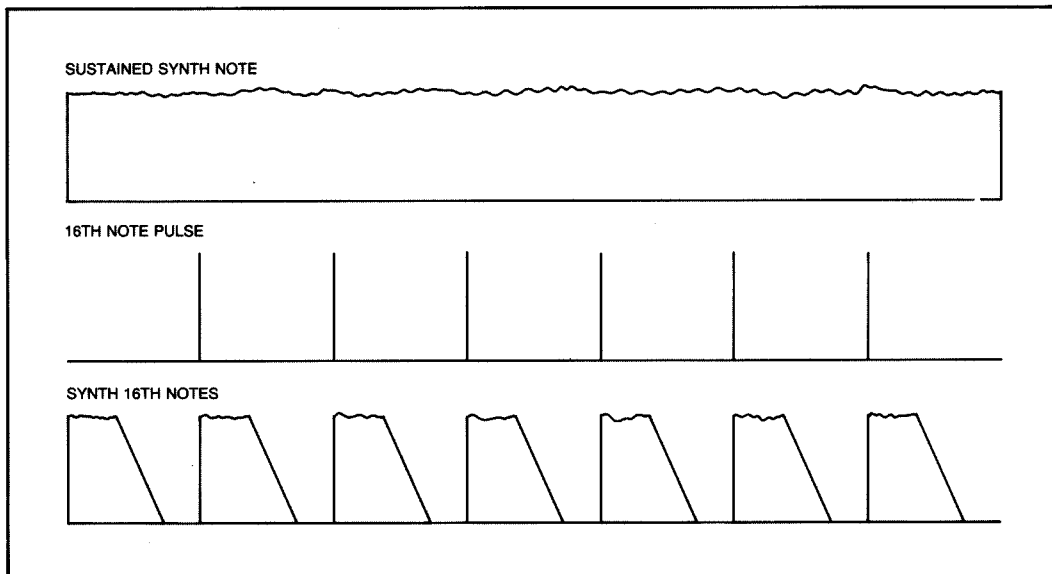

Diagram 12

The synth is set up to provide continuous sustained notes (changing according to the harmony of the song), perhaps being processed by a chorus unit before passing through the gate. A drum machine, or sequencer, is programmed to produce a regular chain of 8th or 16th notes, and is used as the key input to the DN510 (an alternative source of 8th or 16th notes pulses is a live bass drum with added echo, timed to give the appropriate repeats).

By adjusting the Hold and Release times, the synth will appear to play a perfectly timed sequence of notes which will add interest and rhythm to the arrangement.

In a similar way, a bass drum may be 'beefed up' by using it to key a low frequency tone produced by a synth (or even the console oscillator) and mixing this gated tone with the original drum sound. A snare drum may be given added 'bite' by keying high frequency noise.

Ducking

This technique uses the External Key input of the DN510.

If speech is to be mixed with music from a stereo source, it is best if the music is dropped in level during the speech, and raised during pauses. This can be done automatically by passing the music through the DN510 and patching the microphone into the External Key input of one channel:

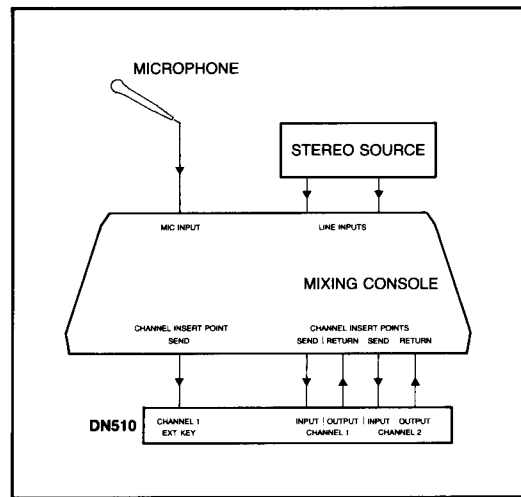

Diagram 13

The **Duck** button is pressed on both channels, and also **Stereo Link** and **Ext Key** (necessary on the right hand channel so that the music input to that channel does not key the gate). An appropriate setting for **Range** is between 5 and 10dB.

This technique is also useful for enhancing the vocals in a mix. The instrument channels can be subgrouped and passed through the DN510 before returning to the main mix. In this way, whenever the vocal is present, the backing track can be made to drop down in level out of the way.

Rhythmic Effects

The provision of **Trigger Mask** and **Delay** controls allows the generation of sophisticated rhythmic effects:

An overly 'busy' snare drum track may be simplified by using the Mask control to keep the gate closed during unwanted fills and offbeats. For example, if the main snare drum pulse comes every second (as would typically happen at a tempo of 120 beats per minute), then the Mask value can be set to just under one second. As long as the first snare drum beat is a wanted beat, all the unwanted beats will be eliminated.

The Delay control can be used to produce 'slap-back' effects by shifting the Attack of the gate by up to 2 seconds. By gating reverb in this way, a delayed reverb effect may be obtained.

MIDI

The principal use of the MIDI function of the DN510 is to replace acoustic drum sounds with samples, or poor samples with better ones. This may be done either live, or off multitrack tape.

In the diagram below, four drums are miked up and fed – via the console – to two DN510 units. The DN510's are set up to trigger correctly on each drum strike. As the gates open and close, MIDI Note On and Note Off messages are sent. The Note On message is sent at the beginning of the Attack phase of the envelope. Note Off is sent at the end of the Hold period.

The MIDI data stream may be cascaded through the MIDI OUT and MERGE IN connections of a series of DN510 units. The MIDI OUT of the final unit is connected to a MIDI sampler. The MIDI OUT of the final unit is connected to a MIDI sampler.

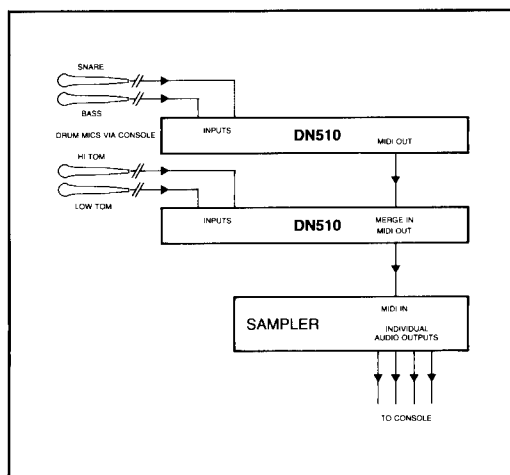

Diagram 14

MIDI parameters are set on small switches on the rear of the unit. **Key Number** is the MIDI Key Number that will be transmitted for each channel (for example, the note Middle C in MIDI terminology is Key Number 60). **Channel Number** is the MIDI channel – 1 to 16 – for the whole unit. **Velocity Range** sets the range of input levels that will produce MIDI Velocity values from 0 to 127 and thus match the dynamics of the sample to those of the original instrument (if MIDI Velocity is selected on the front panel).

A MIDI setting chart is provided on page 33 of this manual.

The Trigger Mask and Envelope Delay functions can be employed with MIDI. For example, using Trigger Mask, a handclap sample could be used to reinforce alternate snare drum beats. Or perhaps a sample could be used to echo a drum beat by delaying the MIDI Note On message.

When the DN510 is used in stereo mode, although the AUDIO function of the right hand channel's envelope controls is disabled, the MIDI function is still active. Any possible conflict between audio and MIDI requirements may be avoided.

The DN510 Advanced Dual Gate has the facilities to provide an almost limitless variety of musical expression. Engineered for total control, the DN510 sets a new standard in creative audio gating.

Audio and MIDI Connections

Input

The input circuit is a transformerless, electronically balanced design which achieves a symmetry of better than -50dB from 20Hz to 10kHz .

If transformer balancing of the input is required, this must be specified at the time of order. It is not retrofittable.

Output

The standard output is unbalanced, but balancing transformers are available and may be retrospectively fitted. The output circuitry is capable of driving a $600\ \text{ohm}$ load at a level of $+22\text{dBu}$.

Input

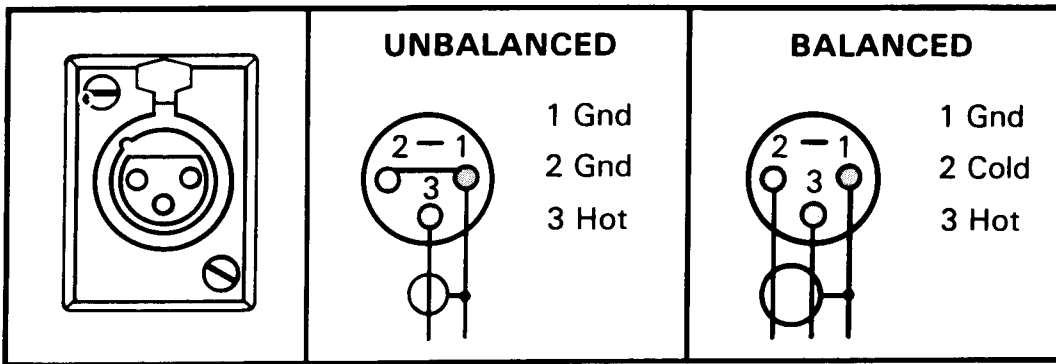

Output

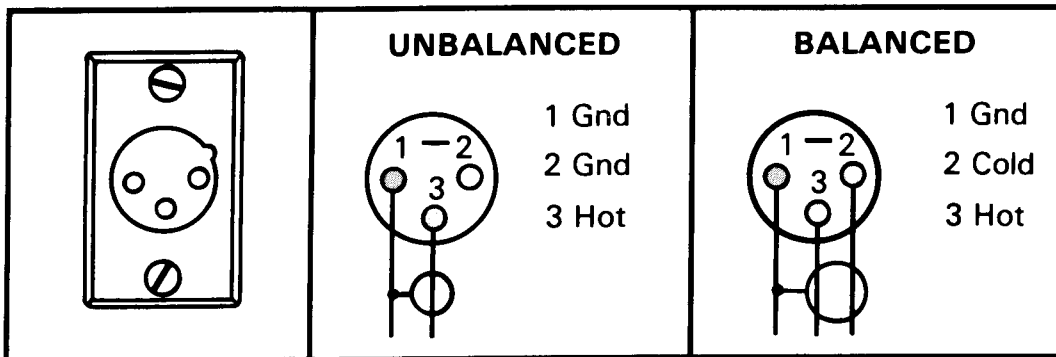

Pin 2/Pin 3 Hot Operation

The unit can be quickly re-configured to accommodate either XLR wiring standard by removing the top cover and changing the orientation of 4 plug-in links per connector, as shown on the adjacent PCB legend. When using a fully balanced system, either pin 2 or pin 3 may be the HOT terminal.

External Key Inputs

The electronically balanced External Key inputs are on stereo quarter inch type A jack sockets, configured TIP = HOT, RING = COLD, SLEEVE = Earth. Inserting a mono jack plug will automatically unbalance the input.

DC Trigger Inputs/Outputs

The DC trigger inputs and outputs are on stereo quarter inch type A jack sockets, configured TIP = Output, RING = Input, SLEEVE = 0 volts.

MIDI Connections

MIDI OUT and MERGE IN are on five pin DIN connectors.

The MIDI OUT can be connected to the MIDI IN on any suitable equipment, with a standard MIDI lead.

If more than one DN510 is being used and a common MIDI OUT is required, units can be cascaded by connecting the MIDI OUT on one unit to the MERGE IN on the next. (Note: MERGE connections must be made using a true five way DIN to DIN lead. Your standard MIDI leads may only have three connections.)

Balanced Circuits

Transformer or electronically balanced connections have the benefit of Common Mode Rejection which eliminates externally induced interference, such as mains hum etc. Balancing is especially useful when long cable runs are used between pieces of equipment.

Transformer balanced circuits have the added advantage of being fully floating, with the earth (ground) or screen being totally isolated from the signal. In installations where a difference in earth potential is likely to occur, this isolation prevents earthing problems which can, in some cases, damage the equipment.

DN510 Technical Specifications

Audio inputs

Type
Impedance (ohms)
 balanced
 unbalanced

Two
Electronically balanced

20k
10k

Key inputs

Type
Impedance (ohms)
 balanced
 unbalanced

Two
Electronically balanced

20k
10k

Audio outputs

Type
Minimum load impedance
Source impedance
Maximum level

Two
Unbalanced
600 ohm
<60 ohm
+21dBu

Performance

Frequency response
 (20Hz to 20kHz)
Distortion
 (+4dBu)
Equivalent input noise
 (20Hz to 20kHz unweighted)

± 0.5 dB

<0.03% at 1kHz

<-100dBu, gate closed
<-94dBu, gate open

Gate

Range

0dB to 90dB attenuation

Filters

High Pass filter
Low Pass filter

25Hz to 5kHz, 12dB/octave
75Hz to 18kHz 12dB/octave

Trigger

Mask Time
Threshold

0 to 4S
-40dBu to +20dBu

Envelope

Delay
Attack
Hold
Release

0 to 2S
10 μ S to 250mS
10mS to 3S
5mS to 2S

MIDI

Output

Note On, Note Off and
Velocity information

Channel Number
Key Number

Adjustable 1 to 16
Adjustable 0 to 127

DC Trigger	
Inputs	+5 volts to open gate
Outputs	+5 volts when gate open
Power requirements	
Voltage	110/120/220/240V, 50/60Hz
Consumption	<30VA
Weight	
Nett	4kg
Shipping	6kg
Dimensions	
Width	482mm (19 inch)
Depth	292mm (11½ inch)
Height	44.5mm (1¾ inch)
Terminations	
Audio inputs/outputs	3 pin XLR
Key inputs	¼ inch stereo jack
DC Trigger input/output	¼ inch stereo jack
MIDI OUT	5 pin DIN
MERGE IN	5 pin DIN
Power	3 pin IEC
Options	
	Security cover
	Transformer input/output balancing*

* Input transformer balancing is non-retrofitable and has to be specified with order.

DN510 Circuit Description

(Note: only Left Channel is described, other channel is identical except where stated.)

Audio Circuits

Input Section

The input signal enters via XLR type connector XL1 and may be balanced or unbalanced (see audio connector wiring details).

The input is then fed through the Hot-Pin jumper block which allows for either Pin 2 or 3 being selected as the in phase or active pin on the input.

The signal is then connected via the first order filter network R222/C81 and R227/C82 to the differential input amplifier circuit consisting of A37a and A37b.

Common mode rejection is factory set with P1 to give maximum rejection at 100Hz; typically 85dB.

VCA Section

The output from A37b passes through the first order LF and HF filter networks C27/R70 and C28/R69 to the VCA input buffer A24a.

From there it is AC coupled to the DBX VCA A25 via C30 and to the EXT/KEY input switch S2 via C29.

Preset P2 is factory set to give minimum distortion at 1kHz and +10dBm, (typically 0.003%), this adjustment also reduces control feed-through to a minimum.

Output Section

The VCA output is fed to the current to voltage convertor A24b which has a high current drive capability. High frequency stability is optimised with capacitor C34.

The output of A24b is AC coupled by C35 to the MONITOR switch S6 and from there via the IN/Out switch S1 to C91.

From C91 the signal is connected to the output transformer socket TC1.

On the standard unit two plug-in links on TC1 connect signal and ground to pins 2 and 3 of the output XLR connector XL2 via the Hot-Pin jumper block.

On units with transformer balanced output the two links are removed and the transformer is connected to TC1.

EXT/KEY Input

The Ext/Key input signal enters via stereo jack connector JK11 and may be balanced or unbalanced (see audio connector wiring details).

The signal then passes to the differential input amplifier A36 which has first order R.F. filter networks formed by R257/C86 and R238/C87.

From A36 the signal is AC coupled to the EXT/KEY selector switch by C88.

On Channel B amplifier A36 is a high current drive type since it can drive the output directly when that channels side chain is being Monitored.

HF and LF Filter Section

The output from the EXT/KEY selector switch is connected to the GATE/TRIG switch S3 and from there is AC coupled by C36 to the positive filter input buffer A26b which has a first order R.F. filter formed by R81/C37. This buffer is needed due to the variable impedance offered by the following filter circuits.

The HF and LF filters are 12dB/octave second order butterworth filters arranged around A27a and A26a respectively.

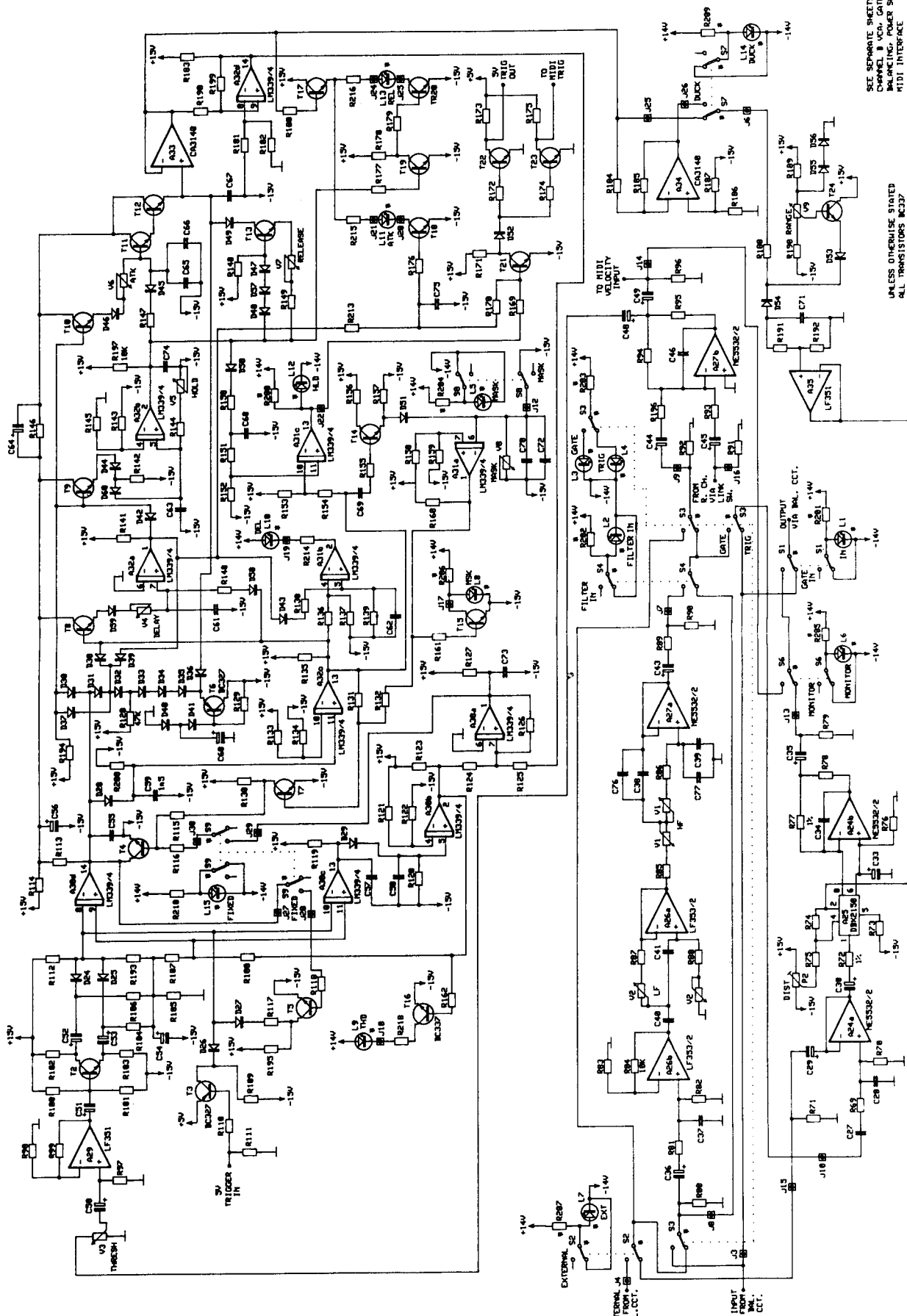

SEE SEPARATE SHEETS FOR
CHANNEL B VCA, GATE AND FILTERS.
BALANCING POWER SUPPLY AND
MIDI INTERFACE

UNLESS OTHERWISE STATED
ALL TRANSISTORS BC337
ALL DIODES 1N4148

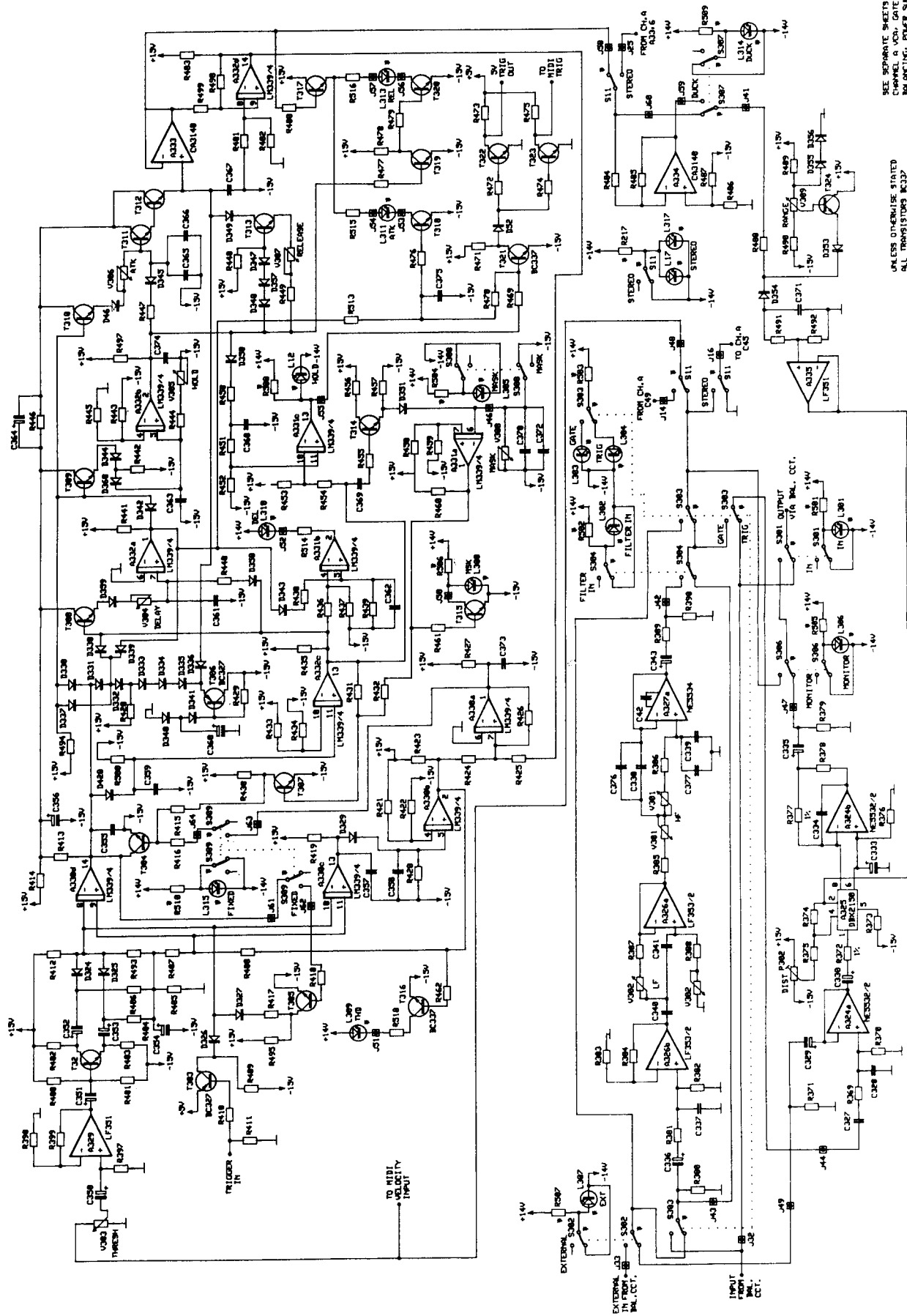

SEE SEPARATE SHEETS FOR
 COMPONENTS AND FILTERS.
 UNLESS OTHERWISE STATED
 ALL TRANSISTORS BC337
 ALL DIODES 1N4148

The turnover frequency for each filter is continuously variable; between 25Hz and 5kHz using V2 for the LF and 75Hz and 18kHz using V1 for the HF.

Both filters are unity gain positive circuits.

Filter output amplifier A27a has a high current drive capability and is AC coupled by C43 to the Filter IN switch S4 and from there via the GATE/TRIG switch S3 to the MONITOR switch S6 and the EXT/KEY Mixer circuit.

EXT/KEY Mixer

On Channel A the signal from the GATE/TRIG switch S3 is fed through AC coupling capacitor C44 to the inverting mixer circuit of A27b.

This mixer circuit has a loss of 6dB and high frequency stability is ensured by C46.

The output of the mixer circuit is fed via C48 and C49 to the THRESHold control V3 and the MONITOR switch S6 respectively.

On Channel B this signal passes through the STEREO Link switch S11 instead of mixer circuits.

This arrangement causes both Channel A and B audio signals to be mixed together and fed to the Channel A control circuits when the unit is Linked in Stereo.

Side Chain Control Circuits

Threshold Control Amplifier

The output from the wiper of the Threshold control V3 is AC coupled via C50 to the positive 40dB amplifier A29.

This stage allows continuously variable selection of threshold level down to -40dBm .

AC to DC Convertor Section

The output of A29 is AC coupled by C51 to the base of transistor T2 which is arranged as a unity gain phase splitter biased for maximum voltage swing on its collector and emitter.

The two out of phase outputs from T2 are AC coupled by C52 and C53 to rectifier diodes D24 and D25. These diodes are biased to 0 Volts by R104, R105 and R106 at their anodes and to a voltage slightly higher by R112 and R193 on their cathodes.

This voltage difference sets the point at which they start to conduct and hence the level needed at T2 to open the gate, the threshold point.

Threshold Detector

The junction of the cathodes of D24 and D25 are also joined to the negative inputs of comparators A30c and A30d the positive inputs of which are biased to approximately 0 Volts.

When the input signal to T2 is above the threshold level the outputs of A30c and A30d will switch high on every half cycle of the input waveform.

The outputs are pulled up by R113 and R119 but the output of A30d is limited to $+2.8\text{V}$ by the voltage clamp circuit of T6, R129, D31 to D35, D40 and D41.

Delay section

The output of A30d is connected via D31 and D38 to the base of emitter follower transistor T8 and this is also connected to the output of comparator A32c.

The emitter voltage of T8 is fed via D59 and the DELAY control V4 to the storage capacitor C61.

The time taken for C61 to rise from -15 volts to 0 volts is therefore adjusted with V4. The top of C61 is also connected to the positive input of comparator A32a and via R140 and D58 to the output of A32c.

The input to comparator A32c is derived from the output of A30d via the Pulse Stretching circuit consisting of D28, C59 and R200 which ensures the output of A32c stays high with input pulses up to 25mS apart.

This allows 20Hz signals to pass without this stage switching on and off with every half cycle.

Whenever A32c does switch off it discharges C61 and resets the Delay circuit.

The result of all this is that the output of A32a stays low for the duration of the Delay time and then switches high.

Hold section

The output of A32a is connected by D42 to the base of transistor T9, which is limited to a maximum voltage of $+2.8$ volts by D37 and the voltage clamp circuit of T6, and is pulled high by R194.

The emitter voltage of T9 is fed via D44 and D60 to storage capacitor C63.

The voltage on C63 is discharged at a rate set by the HOLD control V5 which is wired via R144 to the negative rail.

The top of C63 is connected to the positive input of comparator A32b the negative input of which is joined to a voltage divider consisting of R143 and R145.

The output of A32b is fed to the Hold LED circuit via D50 and to the Attack and Release circuits in order to activate the Release slope and discharge the Attack capacitor.

At the end of the the Delay time the Hold capacitor is charged continuously while the signal is above the Threshold level and when the signal stops it is discharged by the HOLD control.

The time taken for the voltage on the Hold capacitor to reach the divider voltage is the Hold time.

Attack Circuit

The output of A30d is connected by D30 to the emitter follower transistor T10 and then fed through D46 and the ATTACK control V6 into the Attack storage capacitors C65 and C66.

D46 is included to stop the reverse biased zener effect of the base-emitter junction of T10 discharging C65 and C66 when the output of A30d switches low.

To save excessive currents flowing in T10 under continuous attack conditions its collector current is supplied by R146 which is bypassed by C64 in order to cope with switch on transients.

The voltage on C65 and C66 is limited to a maximum of $+1.4\text{V}$ by D46, T10 and the voltage clamp T6.

Release section

The voltage on C65 and C66 is buffered by the darlington pair transistors T11 and T12 and fed to the Release storage capacitor C67, whose maximum voltage is limited to 0 volts by D36 and the voltage clamp T6.

When the output of A32d, the Hold circuit, goes low the constant current release circuit consisting of T13, V7, R148, R149 and D47, D48 and D57 is brought into action. The Release slope is continuously variable with V7 from 5mS to 2 Seconds per 20dB of attenuation.

Buffer circuit

The voltage on C67 is buffered by the high impedance voltage follower A33 the output of which is fed to the Duck circuit and DUCK switch S7.

Duck section

The Ducking or inverted gating action is achieved by unity gain inverting amplifier A34 which is switched into circuit with the DUCK switch S7.

This produces a mirror image of the output voltage of A33 centered on a voltage midway between $-15V$ and $0V$.

Range control

The RANGE control V9 in combination with buffer transistor T24, diodes D53 to D56 and resistors R188 to R190 is used to limit the lowest voltage passed to the VCA control port buffer A35.

This limits the maximum audio attenuation to somewhere between 0dB and $-90dB$.

VCA control port buffer

High impedance unity gain stage A35 is fed by the output of the voltage attenuator R191/R192.

This voltage attenuator serves to reduce the 15V output swing of A33 or A34 down to the 0.54V swing required by the VCA for 90dB audio attenuation.

Mask section

The output of the pulse stretcher circuit A32c is coupled by C69 and R155 to voltage buffer transistor T14.

Capacitor C69 ensures that T14 is only activated on the leading edge of any signal burst. The emitter voltage of T14 charges the Mask storage capacitors C70 and C72 via D51 and they are discharged by the MASK control V8 which is wired to the negative rail. The MASK switch S8 shorts out the storage capacitors to the negative rail when the Mask circuit is switched out.

The top of C70 and C72 are connected to the negative input of comparator A31a the positive input of which is joined to a voltage divider consisting of R158 and R159.

Whenever the voltage on the storage capacitors rises above the divider voltage the output of A31a switches low.

This activates the MSK LED via T15 and causes T7 to switch off at the end of the input burst.

When T7 collector goes high transistor T4 is switched on and this holds the output of A30d at -15 volts, ignoring any further input bursts until the end of the Mask time set with V8.

Fixed System

The inputs to the Fixed System come from the outputs of A30c, which switches high on every half cycle of the input waveform, and A32d, which is high while the gate is fully open and then switches to the negative rail as soon as the gate begins to close.

The output of A30c is fed via the pulse stretching circuit of D29, C58 and R120 to the positive input of A30b, the negative input of which is connected to a voltage divider R121 and R122.

This ensures the output of A30b stays high with input pulses up to 25mS apart, allowing 20Hz signals to pass without this stage switching on and off with every half cycle.

The outputs of A30b and A32d are fed through resistors R124 and R125 to the positive input of comparator A30a which has positive feedback supplied by R126 in order to make this stage a type of latch circuit.

Both the inputs have to go high or low at the same time to make the output of A30a change state.

The output of A30a is fed via the FIXED switch S9 to transistor T4 so that at the end of the Delay and Attack periods, when the gate is fully open, the output of A30d is clamped to the negative rail, switching off the drive to the rest of the circuits.

In order to force the unit to complete its whole dynamic cycle when in the Fixed mode the output of A30d is fed via the FIXED switch to transistor T5 which, when activated, forces the input to A30d low and locks the circuit open until the end of the Hold period.

Indicators

Attack and Release LEDs

The ATK and REL LEDs are switched on and off by T18 and T20 and are faded up and down by the emitter follower transistor T17.

The base of T17 is driven via R180 from the output of A33, the Voltage Buffer, and so the brightness of the ATK and REL LEDs is directly related to the amount of audio attenuation.

The REL LED is activated via T20 and T19 whenever the output of the Hold circuit A32b goes low.

The ATK LED is activated when the output of the Delay circuit A32a goes high.

Delay LED

The DEL LED L10 is driven from the output of comparator A31b whose inputs are derived from the outputs of A32a, the Delay circuit, and A32c, the input Pulse Stretcher circuit.

The input networks are arranged in such a way that the output of A31b goes low during the Delay period with A32c output high and A32a output low.

The pulse stretcher circuit consisting of D43, C62, R138 and R139 on the positive input of A31b is included to match the effect of the input Pulse Stretcher as otherwise the LED would be on for longer than the Delay time.

Hold LED

The HOLD LED L12 is driven from the output of comparator A31c whose inputs are derived from the outputs of A32b, the Hold circuit, and A32c, the input Pulse Stretcher circuit.

The input networks are arranged in such a way that the output of A31c goes high during the Hold period with A32c output low and A32b output high.

The pulse stretcher circuit consisting of D50, C68, and R150 to R152 on the positive input of A31c is included to match the effect of the input Pulse Stretcher as otherwise the LED would be on for longer than the Hold time.

Threshold LED

The THD LED is driven by transistor T16 the base of which is connected via R162 to the output of A30b, the Fixed system pulse stretcher circuit.

This output is used to drive the LED in preference to the main control path Pulse Stretcher output so that the THD LED will show signal present even while the Mask or Fixed systems are operating.

Trigger Circuits

The 5V Trigger Input is connected via R110 to the base of T3 which with no input is pulled low by R111.

When a 5V input voltage is received T3 switches off allowing R109 to pull low the cathode of D26, which is connected to the inputs of A30c and A30d, simulating an audio input above threshold.

The 5V Trigger Output

The drives to the Trigger first stage transistor T21 are derived from the output of the Delay circuit A32a and the output of the Hold LED circuit A31c.

The voltage from the collector of T21 is fed via D52 to the second stage transistors T22 and T23, the collectors of which actually provide the 5V Trigger output and the MIDI Trigger output respectively.

The Trigger output circuits are designed to switch high, to +5V, at the end of the Delay period and switch low again at the end of the Hold period.

MIDI Output Circuit

The MIDI output circuit on the DN510 is not microprocessor based and uses standard 74HCT type ICs throughout.

This causes the parts count to be relatively high but the operation of the circuit is straightforward and, once the basic workings are understood, any fault can be found and fixed very easily.

Each MIDI event consists of three 8-bit bytes, the first giving the type of event (Note On or Note Off) and the MIDI channel number, the second contains the 7-bit MIDI Note Number for that event, and the last byte contains the 7-bit Velocity data word.

Input Sections

There is a total of six inputs to the MIDI circuit, four of them internal, two from each channel, and the last two external from the MIDI Link In socket.

The inputs from each channel consist of the MIDI trigger DC signal, which causes the Note On and Note Off information to be generated, and the MIDI Velocity audio signal, the level of which at the moment of the trigger signal gives rise to the MIDI velocity information sent with the Note On event.

The following description is for Channel A input circuits only, Channel B circuits are identical.

Trigger input

The collector of T23 is connected to the input of inverter A38f, the output of which drives inverter A38e via a 0.33mS R/C delay circuit consisting of R45 and C5.

This delays the MIDI Note on trigger event sufficiently for the signal level to rise to a representative level above threshold before the Velocity information is extracted, as otherwise all the Velocity data would have the value of whatever Threshold was set on the front panel.

The output of A38e is directly connected to inverter A38d and via C7 to the /R input of RS latch A16d.

The output of A38d is connected via C9 to the /R input of RS latch A16c.

These two latches, A16c and A16d, are therefore reset whenever the MIDI trigger line switches to 5V or 0V respectively, they store the fact that a transition has occurred until the rest of the circuit has time to process the information.

Velocity input

The audio signal from the top of the Threshold control is fed via C110 to a precision rectifier circuit comprised of A1b, A2b, D1 and D3.

Rectifier output stage A2b has switchable gain and this is set using the Velocity Range Select switches DS1c and DS1d on the rear panel of the unit.

The output of A2b is fed via a fast attack, slow release circuit consisting of D5, D7, R15, R17 and C3 to high impedance voltage follower circuit A3.

The output of A3 is connected via the MIDI VEL switch S10 to one input of Analogue Multiplexer A8.

When the MIDI VEL switch is off resistors R19 and R21 hold the input of A8 at approximately +1.25V, which is mid range for the following stage, the 8-bit Analogue to Digital convertor A7.

Clock circuits

A standard 4MHz clock circuit is used comprising crystal X1 and inverters A21f and A21e, C107 is included for stability.

The output of A21e is fed via buffer inverter A21d to 2-input Nand gate A22d, the other input to A22d coming from the MIDI In/Out control section and acting as an inhibit line for the oscillator output.

The output of A22d is connected to cascaded Binary 4 bit Counters A14a and A14b.

Three of the outputs of these counters are used, the 1MHz output to act as the clock feed for the A to D convertor A7, the 62.5kHz output to drive the channel selector A15 and the 31.25kHz output to drive the four cascaded 8-bit Parallel to Serial Convertors which form the heart of the MIDI circuit.

Channel Selector circuit

The 62.5kHz output from the oscillator divider circuit is fed via A22b and A22a to the cascaded D-type Latches A15a and A15b.

These Latches are wired as dividers and their outputs feed off to various parts of the circuit to select Channel A or B with the output of A15b and Note On or Note Off with the A15a output.

When the circuit is free running, i.e. no trigger event has been input, the outputs of these latches constantly cycle round the four Trigger input RS latches by means of a 1 of 4 decoder A18b and a 4-input Multiplexer A17.

Latch and Counter circuits

If any of the Input RS latches have been reset, i.e. a trigger event has occurred, then the output low signal is passed by A17 to the RS latch formed by the 2-input Nand gates A20c and A20d.

The output of A20d goes low and inhibits further cycling of the Channel Selector circuit by its connection to A22b.

The output of A20c is fed via A20b and Inverter A23f to the enable input of the Counter circuit A13, the Shift/Load inputs of the Parallel to Serial convertors and to the activate input of the MIDI In/Out circuit.

Nand gate A20b acts as an inhibit for the feed from A20c while the A to D convertor circuits /Busy output is low.

The four Parallel to Serial convertors on receipt of the signal from A23f take whatever data is on their parallel inputs and send it out as a serial stream to the MIDI In/Out circuit.

The Counter circuit consisting of 2-input Nand gate A20a, 4-bit Counters A13b, A13a and Inverter A23d counts to 32 when started by A23f and then due to the feedback connection of R62 and C19 resets itself to its initial state.

The pulse generated at the output of A23d while the Counter is resetting is fed to the reset input of the RS latch circuit of A20c and A20d.

The latch resets and the Channel selector starts cycling again.

The pulse from A23d is also fed via the 1 of 4 Decoder A18b to the set input of the Input RS latch which originally triggered the whole event.

Parallel to Serial Convertor Data inputs

The MIDI channel number and individual Channel A and B Data words are user selected with the DIL switches DS1, DS2 and DS3 on the rear panel of the unit.

The outputs from DS1 are fed directly to A9, the first convertor in the chain.

This convertor also receives an input from the Channel Selector circuit Note On/Note Off section.

The outputs of the Channel A and B Data switches are fed via the two quad 2-input Multiplexers A5 and A6 to the second and third convertors in the chain.

The Multiplexers A5 and A6 receive their A/B select signal from the Channel Selector circuit via inverter A23c.

The Velocity information output by the A to D Convertor A7 is fed directly to inputs on the third and fourth convertors.

This all generates the three 8-bit bytes required by the MIDI format surrounded by leading and trailing null data bits to ensure correct operation.

MIDI In/Out circuit

The circuit consisting of A19, A21a, A21b, A21c and T1 is designed to output the data stream produced by the Parallel to Serial convertors and also to pull the Link line low while data is being sent to tell any other Linked units to wait until it has finished.

The Link line acts as an input as well as an output in that if it goes low while the unit is not sending data then the circuit freezes all internal MIDI operations and joins the Link socket MIDI In data line to the units MIDI Out driver circuit.

All connections to the MIDI sockets are protected against improper connections by R63, R65, R68 and D20 to D23.

Power Supply

The power supply is a $\pm 15V$ design using a low noise toroidal transformer with split primary and secondary windings.

The two primaries are connected in series or in parallel by MVS \overline{W} to give 220 or 110 Volt nominal operation.

The secondaries drive a full wave bridge rectifier, D61 to D64, 2 smoothing capacitors, C99 and C100, and integrated circuit positive and negative 15 volt regulators REG1 and REG2.

Decoupling capacitors C95, C96, C390 and C395 at the power supply and C31, C32, C90, C92, C93 and C108 in each channel ensure low noise supply rails.

The positive 15 volt regulator also drives a 5 volt integrated circuit regulator REG3, which has suppression capacitors C15, C22, C23, C25, C26, C103, C104, C701 and C802 to ensure a smooth 5 volt supply.

Power 'on' is indicated by LED L18 which is connected between the +15V and -15V rails via R242.

MIDI Setting Chart

Key Number				Key Number															
Note	MIDI Key	Key Number Switches							Note	MIDI Key	Key Number Switches								
		1	2	4	8	16	32	64	0			1	2	4	8	16	32	64	0
C-2	0	-	-	-	-	-	-	-	-	B-1	23	1	2	3	-	5	-	-	-
C-2#	1	1	-	-	-	-	-	-	-	C0	24	-	-	-	4	5	-	-	-
D-2	2	-	2	-	-	-	-	-	-	C0#	25	1	-	-	4	5	-	-	-
D-2#	3	1	2	-	-	-	-	-	-	D0	26	-	2	-	4	5	-	-	-
E-2	4	-	-	3	-	-	-	-	-	D0#	27	1	2	-	4	5	-	-	-
F-2	5	1	-	3	-	-	-	-	-	E0	28	-	-	3	4	5	-	-	-
F-2#	6	-	2	3	-	-	-	-	-	F0	29	1	-	3	4	5	-	-	-
G-2	7	1	2	3	-	-	-	-	-	F0#	30	-	2	3	4	5	-	-	-
G-2#	8	-	-	-	4	-	-	-	-	G0	31	1	2	3	4	5	-	-	-
A-2	9	1	-	-	4	-	-	-	-	G0#	32	-	-	-	-	-	6	-	-
A-2#	10	-	2	-	4	-	-	-	-	A0	33	1	-	-	-	-	6	-	-
B-2	11	1	2	-	4	-	-	-	-	A0#	34	-	2	-	-	-	6	-	-
C-1	12	-	-	3	4	-	-	-	-	B0	35	1	2	-	-	-	6	-	-
C-1#	13	1	-	3	4	-	-	-	-	C1	36	-	-	3	-	-	6	-	-
D-1	14	-	2	3	4	-	-	-	-	C1#	37	1	-	3	-	-	6	-	-
D-1#	15	1	2	3	4	-	-	-	-	D1	38	-	2	3	-	-	6	-	-
E-1	16	-	-	-	-	5	-	-	-	D1#	39	1	2	3	-	-	6	-	-
F-1	17	1	-	-	-	5	-	-	-	E1	40	-	-	-	4	-	6	-	-
F-1#	18	-	2	-	-	5	-	-	-	F1	41	1	-	-	4	-	6	-	-
G-1	19	1	2	-	-	5	-	-	-	F1#	42	-	2	-	4	-	6	-	-
G-1#	20	-	-	3	-	5	-	-	-	G1	43	1	2	-	4	-	6	-	-
A-1	21	1	-	3	-	5	-	-	-	G1#	44	-	-	3	4	-	6	-	-
A-1#	22	-	2	3	-	5	-	-	-	A1	45	1	-	3	4	-	6	-	-

MIDI Setting Chart (cont.)

Key Number				Key Number															
Note	MIDI Key	Key Number Switches								Note	MIDI Key	Key Number Switches							
		1	2	4	8	16	32	64	0			1	2	4	8	16	32	64	0
A1#	46	-	2	3	4	-	6	-	-	A3	69	1	-	3	-	-	-	7	-
B1	47	1	2	3	4	-	6	-	-	A3#	70	-	2	3	-	-	-	7	-
C2	48	-	-	-	-	5	6	-	-	B3	71	1	2	3	-	-	-	7	-
C2#	49	1	-	-	-	5	6	-	-	C4	72	-	-	-	4	-	-	7	-
D2	50	-	2	-	-	5	6	-	-	C4#	73	1	-	-	4	-	-	7	-
D2#	51	1	2	-	-	5	6	-	-	D4	74	-	2	-	4	-	-	7	-
E2	52	-	-	3	-	5	6	-	-	D4#	75	1	2	-	4	-	-	7	-
F2	53	1	-	3	-	5	6	-	-	E4	76	-	-	3	4	-	-	7	-
F2#	54	-	2	3	-	5	6	-	-	F4	77	1	-	3	4	-	-	7	-
G2	55	1	2	3	-	5	6	-	-	F4#	78	-	2	3	4	-	-	7	-
G2#	56	-	-	-	4	5	6	-	-	G4	79	1	2	3	4	-	-	7	-
A2	57	1	-	-	4	5	6	-	-	G4#	80	-	-	-	-	5	-	7	-
A2#	58	-	2	-	4	5	6	-	-	A4	81	1	-	-	-	5	-	7	-
B2	59	1	2	-	4	5	6	-	-	A4#	82	-	2	-	-	5	-	7	-
C3	60	-	-	3	4	5	6	-	-	B4	83	1	2	-	-	5	-	7	-
C3#	61	1	-	3	4	5	6	-	-	C5	84	-	-	3	-	5	-	7	-
D3	62	-	2	3	4	5	6	-	-	C5#	85	1	-	3	-	5	-	7	-
D3#	63	1	2	3	4	5	6	-	-	D5	86	-	2	3	-	5	-	7	-
E3	64	-	-	-	-	-	-	7	-	D5#	87	1	2	3	-	5	-	7	-
F3	65	1	-	-	-	-	-	7	-	E5	88	-	-	-	4	5	-	7	-
F3#	66	-	2	-	-	-	-	7	-	F5	89	1	-	-	4	5	-	7	-
G3	67	1	2	-	-	-	-	7	-	F5#	90	-	2	-	4	5	-	7	-
G3#	68	-	-	3	-	-	-	7	-	G5	91	1	2	-	4	5	-	7	-

MIDI Setting Chart (cont.)

Key Number				Key Number															
Note	MIDI Key	Key Number Switches							Note	MIDI Key	Key Number Switches								
		1	2	4	8	16	32	64	0			1	2	4	8	16	32	64	0
G5#	92	-	-	3	4	5	-	7	-	D7	110	-	2	3	4	-	6	7	-
A5	93	1	-	3	4	5	-	7	-	D7#	111	1	2	3	4	-	6	7	-
A5#	94	-	2	3	4	5	-	7	-	E7	112	-	-	-	-	5	6	7	-
B5	95	1	2	3	4	5	-	7	-	F7	113	1	-	-	-	5	6	7	-
C6	96	-	-	-	-	-	6	7	-	F7#	114	-	2	-	-	5	6	7	-
C6#	97	1	-	-	-	-	6	7	-	G7	115	1	2	-	-	5	6	7	-
D6	98	-	2	-	-	-	6	7	-	G7#	116	-	-	3	-	5	6	7	-
D6#	99	1	2	-	-	-	6	7	-	A7	117	1	-	3	-	5	6	7	-
E6	100	-	-	3	-	-	6	7	-	A7#	118	-	2	3	-	5	6	7	-
F6	101	1	-	3	-	-	6	7	-	B7	119	1	2	3	-	5	6	7	-
F6#	102	-	2	3	-	-	6	7	-	C8	120	-	-	-	4	5	6	7	-
G6	103	1	2	3	-	-	6	7	-	C8#	121	1	-	-	4	5	6	7	-
G6#	104	-	-	-	4	-	6	7	-	D8	122	-	2	-	4	5	6	7	-
A6	105	1	-	-	4	-	6	7	-	D8#	123	1	2	-	4	5	6	7	-
A6#	106	-	2	-	4	-	6	7	-	E8	124	-	-	3	4	5	6	7	-
B6	107	1	2	-	4	-	6	7	-	F8	125	1	-	3	4	5	6	7	-
C7	108	-	-	3	4	-	6	7	-	F8#	126	-	2	3	4	5	6	7	-
C7#	109	1	-	3	4	-	6	7	-	G8	127	1	2	3	4	5	6	7	-

MIDI Setting Chart (cont.)

Channel Number		Channel Number	
MIDI Channel	Channel Number Switches	MIDI Channel	Channel Number Switches
	1 2 4 8		1 2 4 8
1	- - - -	9	- - - 8
2	5 - - -	10	5 - - 8
3	- 6 - -	11	- 6 - 8
4	5 6 - -	12	5 6 - 8
5	- - 7 -	13	- - 7 8
6	5 - 7 -	14	5 - 7 8
7	- 6 7 -	15	6 7 8
8	5 6 7 -	16	5 6 7 8

Velocity Range

Input level (dBu)	Velocity Range Switches	
	Left	Right
-20 to 0	- -	- -
-10 to +10	1 -	3 -
0 to +20	- 2	- 4

Warranty

This product is manufactured by Klark-Teknik and is warranted to be free from defects in components and factory workmanship under normal use and service for a period of one year from the date of purchase.

During the warranty period Klark-Teknik will undertake to repair or at its option, replace this product at no charge to its owner when failing to perform as specified, provided the unit is returned shipping pre-paid, to the factory or authorised service facility.*

No other warranty is expressed or implied.**

This warranty shall not be applicable and be void when this product is subjected to:

- a) Repair work or alteration by persons other than those authorised by Klark-Teknik in such a manner as to injure, in the sole judgement of Klark-Teknik, the performance, stability, reliability or safety of this product.
- b) Misuse, negligence, accident, act of God, war or civil insurrection.
- c) Connection, installation, adjustment or use otherwise than in accordance with the instructions provided by Klark-Teknik.

* See enclosed service request form.

** "MELT" filter circuits used in the Series 300 Graphic Equalisers are warranted for 5 years.

Klark-Teknik reserves the right to alter specifications without notice. This warranty does not affect the statutory rights of the UK customer.



COPYMASTER DO NOT REMOVE

NOTE! This sheet is your Copymaster. Please duplicate on photocopier when needed.

Service Request Form

Please complete this form and send it to Klark-Teknik before returning the unit. Attach duplicate to the returned unit.

NAME TELEPHONE

ADDRESS
.....
.....
.....

MODEL No. SERIAL No.

PURCHASED FROM DATE

Please tick appropriate box

REPLACEMENT PACKING REQUIRED YES NO

- 1) Describe symptoms of malfunction.
- 2) Which channel(s) exhibit(s) the problem?
- 3) Under what conditions does the problem occur?
 - a) All the time
 - b) After a while
 - c) At high signal levels
 - d) At high temperatures
 - e) Other (please explain)

Is the fault: Permanent Intermittent

- 4) What did you do to isolate the problem to this unit?
- 5) Further comments.

Important Note:

It is often useful to call your dealer or the factory explaining the nature of the problem with the unit. In many instances the problem can be solved without returning the unit to the factory. If the unit has to be returned to the factory, use the original packing only. If you do not have the original packing, we will provide a replacement.

Factory authorised service facilities are located throughout the world. Call your dealer or the factory for the location of the service facility nearest you.

Klark Teknik Research Ltd
Klark Industrial Park
Walter Nash Road
Kidderminster
Worcestershire
DY11 7HJ
England

Tel: (0562) 741515
Telex: 339821 KLARTK G
Fax: (0562) 745371

Klark Teknik Electronics Inc.
30B Banfi Plaza North
Farmingdale
NY 11735
USA

Tel: (516) 249 3660
Fax: (516) 420 1863

Klark Teknik is Interested in Knowing You!

Klark Teknik takes a particular interest in the way its products are used, and in the people using them.

Your opinions and requirements are very important to us so that we can continue providing you with the right types of product and features you need. Please consider helping us to achieve this aim. You can do so by completing and returning the enclosed "PRODUCT REGISTRATION CARD". This will enable us to maintain a thorough understanding of our user base, and consequently to design and manufacture useful products to help you solve the various problems you might encounter in the course of your work.

Thank you for your cooperation.

The Klark Teknik Group of Companies

Other companies in the group are Dearden Davies Associates, designers and manufacturers of audio mixing consoles and electronic crossovers.

Midas, the audio mixing console manufacturer, has been totally integrated into Klark Teknik Research Ltd.